

Door Closer:	2 pieces door closer system with standard arm acc. to EN 1154 silver coloured mounted on hinge side. Door coordinator and 2 pieces of 30 mm high brackets with plastic roller.	
Fitting:	Active leaf with mortise lock with latch lever function acc. to EN 12209 (prepared for installation of a profile cylinder lock, provided by customer). Door handle set in acc. to EN 1906 fixed pivoted synthetic material black in U-shape with rounded short-plate. Passive leaf with self-locking concealed shoot bolt lock with upper switch lock.	
Surface:	Door leaf and frame galvanized und primed with 2K-PUR primer (Very High Solid) similar RAL 7035.	
Installation:	masonry	≥ 175 mm
	concrete	≥ 140 mm
	areated concrete	≥ 200 mm
	mounting wall F60	≥ 125 mm

Alternative: PLANE Line PL 902 PREMIUM with flush mounted optics

Frame:	3-sided circumferential rebated PLANE Line special corner frame for flush mounted optics on hinge side. With visible, black coated intumescent material in rebate. High-quality multi-chamber sealing profile adjustable fixed in the three-sided groove.	
Hinges:	Object hinges type VB-3D 160 adjustable in three dimensions. Fixture element with slide bearings inside for smooth door movement.	
Door Closer:	Slide rail door closer system acc. to EN 1154 silver coloured mounted on hinge side.	

Alternative: PLANE Line PL 902 SUPERIOR with flush mounted optics

Frame:	3-sided circumferential rebated PLANE Line special corner frame for flush mounted optics on hinge side. With visible, black coated intumescent material in rebate. High-quality multi-chamber sealing profile adjustable fixed in the three-sided groove.	
Hinges:	Concealed hinge system adjustable in three dimensions.	
Door Closer:	Concealed slide rail door closer system acc. to EN 1154 integrated in frame and door leaf.	

Supplementary Equipment

Glazing:	F90 fire-protective glazing fixed with profiled and visible screwed steel glazing bars. Minimum border 125 mm on side and top, base 300 mm.	
Stainless Steel:	Material 1.4301 (V2A) or 1.4404 (V4A), Surface mill finish or brushed.	
BUCHELE DELUXE:	The exclusive surface coating.	

BASIC - Version

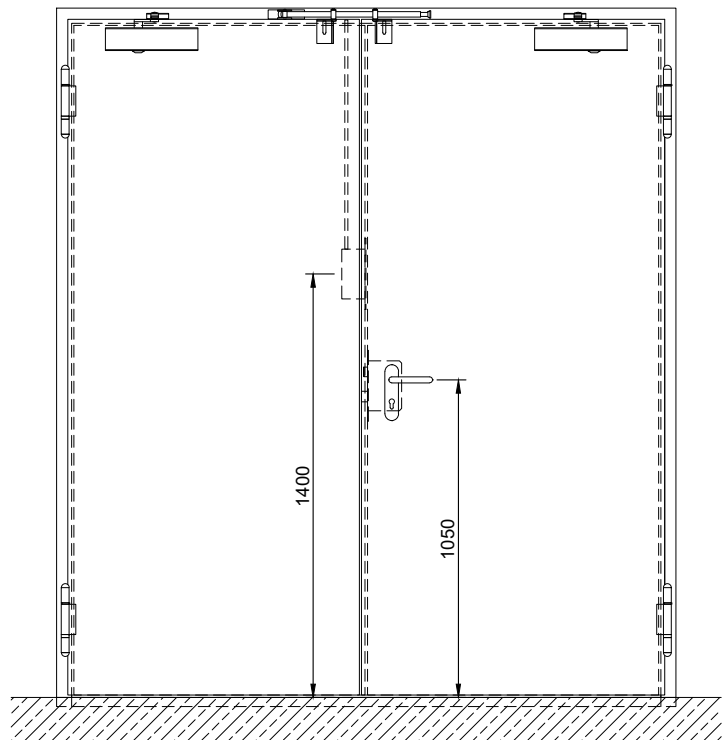
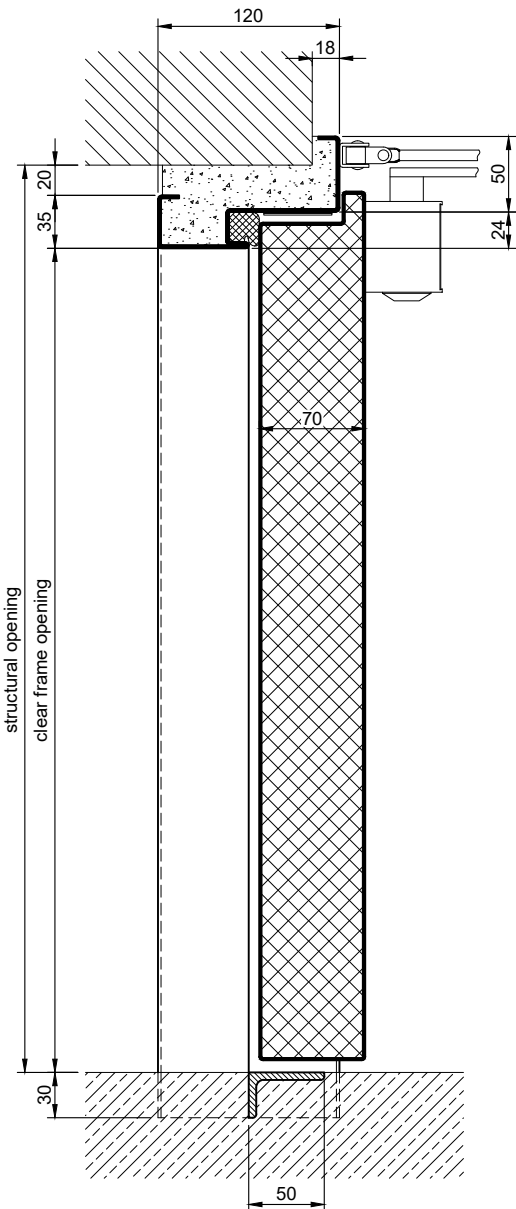
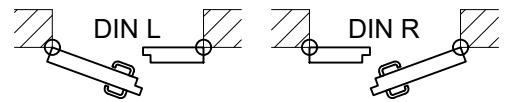
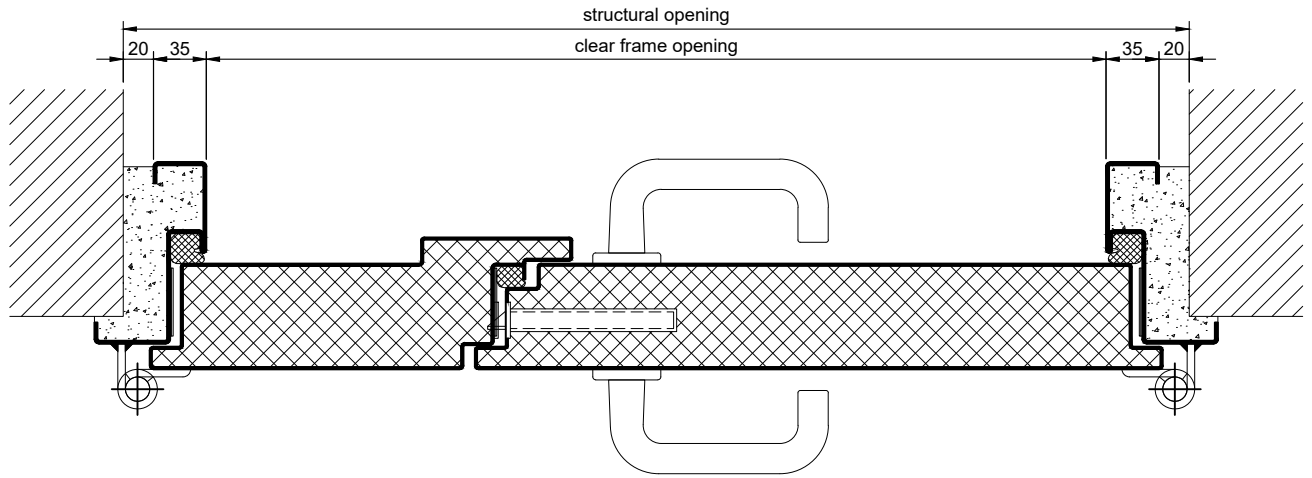

1.50.1_PLANE LINE PL 902_EN

PREMIUM Version

object hinges VB-3D

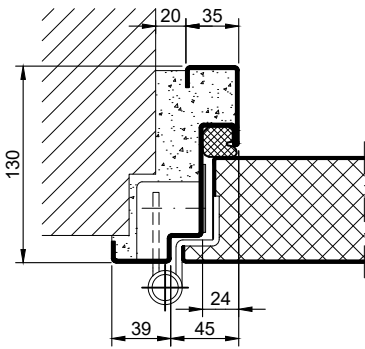

construction hinges

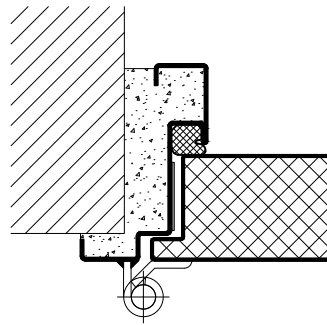

slide rail door closer

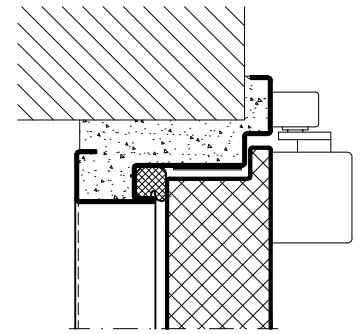

SUPERIOR Version

concealed hinges

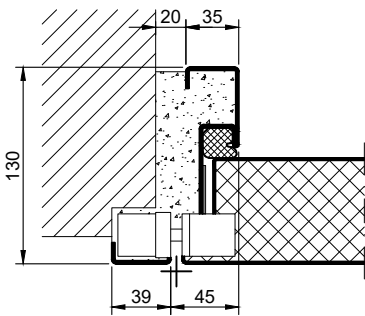

integrated door closer

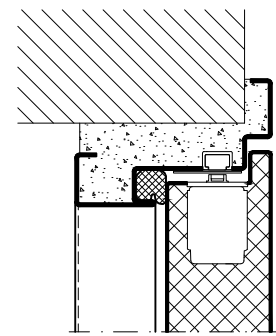

Options

glazing

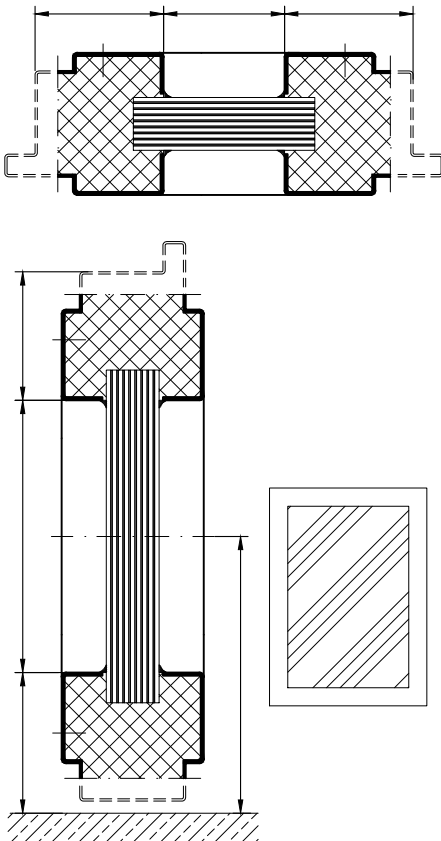

1.50.1 PLANE LINE PL 902_EN

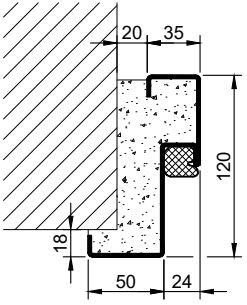
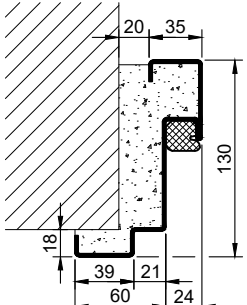
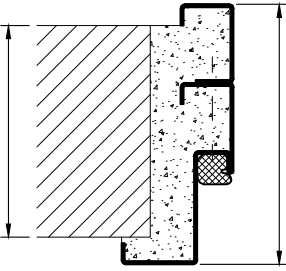
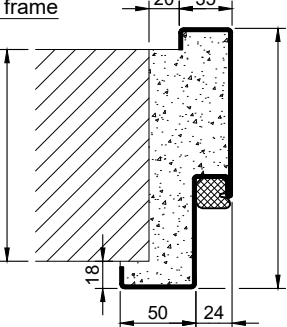
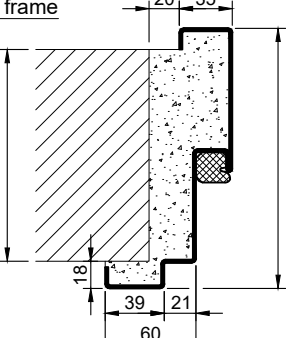
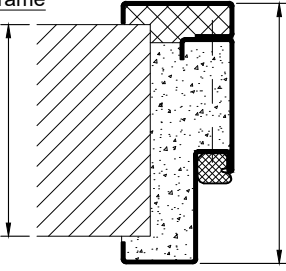
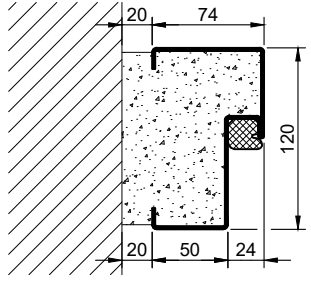
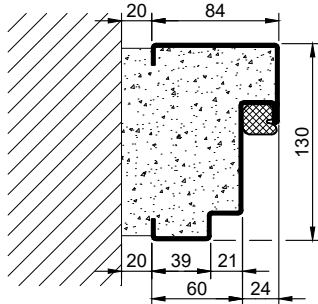
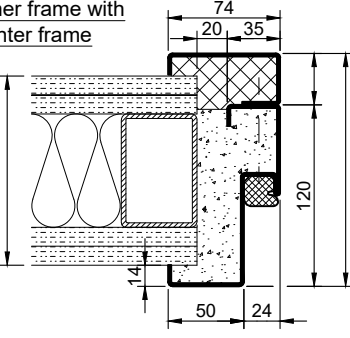
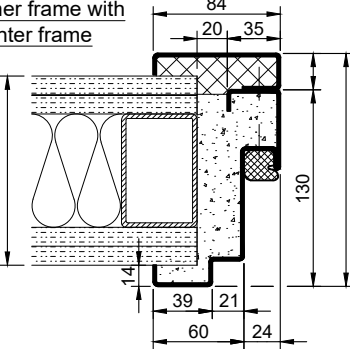
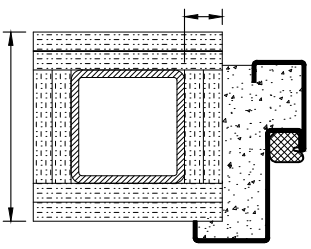
Frames BASIC	Frames PREMIUM/SUPERIOR	Variants (illustration BASIC)
<p>corner frame</p> 	<p>corner frame</p> 	<p>corner frame with additional frame</p> 
<p>encasing frame</p> 	<p>encasing frame</p> 	<p>encasing frame with counter frame</p> 
<p>block frame</p> 	<p>block frame</p> 	
<p>corner frame with counter frame</p> 	<p>corner frame with counter frame</p> 	<p>corner frame at support / pillar</p> 

Thresholds

separation sill

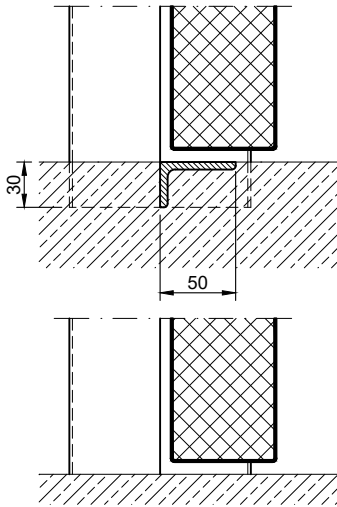

drop seal

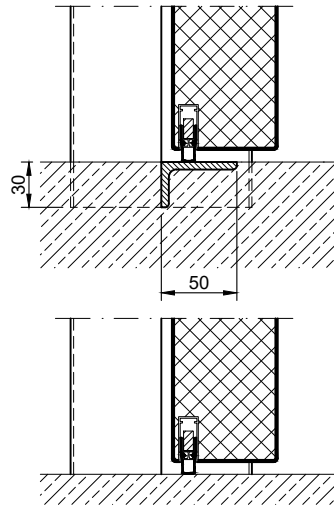

stop sill with seal

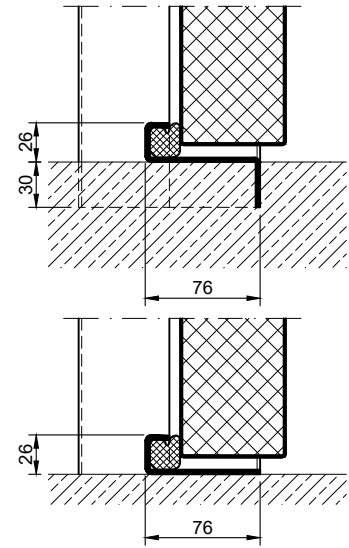

stop sill with seal

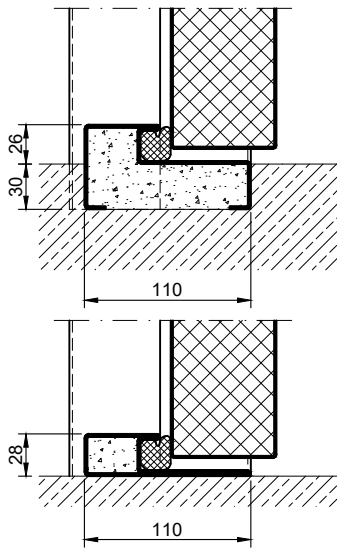

stop sill without seal

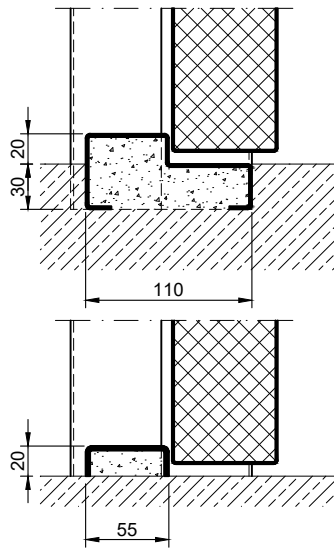

stop sill with drop seal

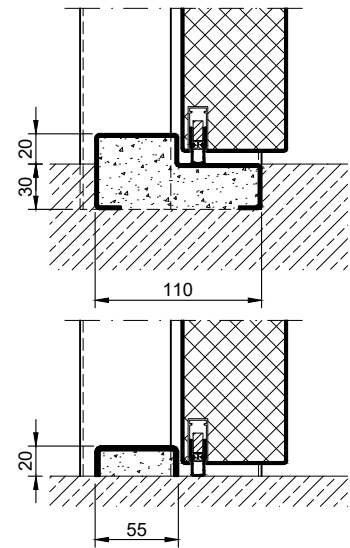

full sill

